

CONDENSING UNIT

HEAT PUMP

INSTALLATION & SERVICE REFERENCE

Goodman Manufacturing Company, L.P. © 2005-2007

5151 San Felipe, Suite 500, Houston, TX 77056

www.goodmanmfg.com -or- www.amana-hac.com

P/N: IO-259F Date: July 2007

Important Safety Instructions

The following symbols and labels are used throughout this manual to indicate immediate or potential safety hazards. It is the owner's and installer's responsibility to read and comply with all safety information and instructions accompanying these symbols. Failure to heed safety information increases the risk of personal injury, property damage, and/or product damage.

WARNING

HIGH VOLTAGE!
 Disconnect ALL power before servicing.
 Multiple power sources may be present.
 Failure to do so may cause property damage,
 personal injury or death.



WARNING

Installation and repair of this unit should be performed **ONLY** by individuals meeting the requirements of an "entry level technician" as specified by the Air Conditioning and Refrigeration Institute (ARI). Attempting to install or repair this unit without such background may result in product damage, personal injury or death.

CAUTION

Scroll equipped units should never be used to evacuate the air conditioning system. Vacuums this low can cause internal electrical arcing resulting in a damaged or failed compressor.

Shipping Inspection

Always keep the unit upright; laying the unit on its side or top may cause equipment damage. Shipping damage, and subsequent investigation is the responsibility of the carrier. Verify the model number, specifications, electrical characteristics, and accessories are correct prior to installation. The distributor or manufacturer will not accept claims from dealers for transportation damage or installation of incorrectly shipped units.

Codes & Regulations

This product is designed and manufactured to comply with national codes. Installation in accordance with such codes and/or prevailing local codes/regulations is the responsibility of the installer. The manufacturer assumes no responsibility for equipment installed in violation of any codes or regulations.

The United States Environmental Protection Agency (EPA) has issued various regulations regarding the introduction and disposal of refrigerants. Failure to follow these regulations may harm the environment and can lead to

the imposition of substantial fines. Should you have any questions please contact the local office of the EPA.

If replacing a condensing unit or air handler, the system must be manufacturer approved and Air Conditioning and Refrigeration Institute (ARI) matched. **NOTE:** Installation of unmatched systems is strongly discouraged.

Operating the unit in a structure that is not complete (either as part of new construction or renovation) will void the warranty.

Installation Clearances

Special consideration must be given to location of the condensing unit(s) in regard to structures, obstructions, other units, and any/all other factors that may interfere with air circulation. Where possible, the top of the unit should be completely unobstructed; however, if vertical conditions require placement beneath an obstruction **there should be a minimum of 60 inches between the top of the unit and the obstruction(s)**. The specified dimensions meet requirements for air circulation only. Consult all appropriate regulatory codes prior to determining final clearances.

Another important consideration in selecting a location for the unit(s) is the angle to obstructions. Either side adjacent the valves can be placed toward the structure provided the side away from the structure maintains minimum service clearance. Corner installations are strongly discouraged.

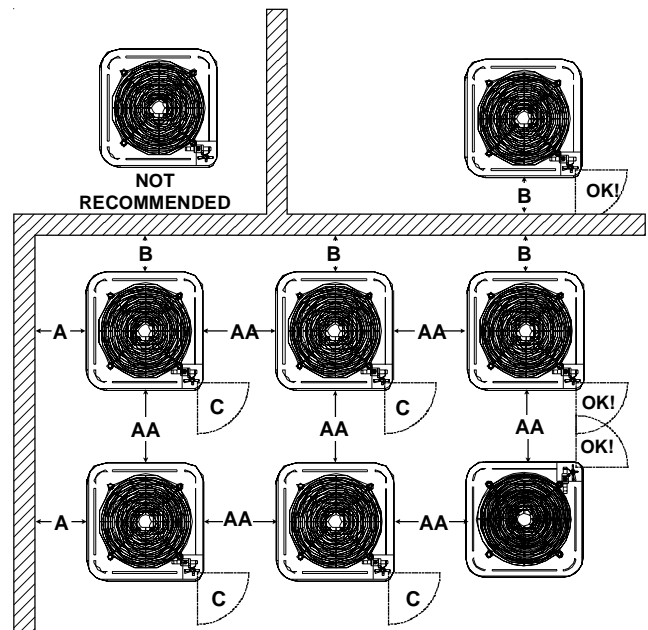

Minimum Airflow Clearance				
Model Type	A	B	C	AA
Residential	10"	10"	18"	20"
Light Commercial	12"	12"	18"	24"

This unit can be located at ground floor level or on flat roofs. At ground floor level, the unit must be on a solid, level foundation that will not shift or settle. To reduce the possibility of sound transmission, the foundation slab should not be in contact with



or be an integral part of the building foundation. Ensure the foundation is sufficient to support the unit. A concrete slab raised above ground level provides a suitable base.

Rooftop Installations

If it is necessary to install this unit on a roof structure, ensure the roof structure can support the weight and that proper consideration is given to the weather-tight integrity of the roof. Since the unit can vibrate during operation, sound vibration transmission should be considered when installing the unit. Vibration absorbing pads or springs can be installed between the condensing unit legs or frame and the roof mounting assembly to reduce noise vibration.

NOTE: These units require special location consideration in areas of heavy snow accumulation and/or areas with prolonged continuous subfreezing temperatures. Heat pump unit bases have cutouts under the outdoor coil that permit drainage of frost accumulation. Situate the unit to permit free unobstructed drainage of the defrost water and ice. A minimum 3" clearance under the outdoor coil is required in the milder climates. In more severe weather locations, it is recommended that the unit be elevated to allow unobstructed drainage and air flow. The following elevation minimums are recommended:

Design Temperature	Suggested Minimum Elevation
+15° and above	2 1/2"
-5° to +14°	8"
below -5°	12"

Safe Refrigerant Handling

While these items will not cover every conceivable situation, they should serve as a useful guide.

 **WARNING**
To avoid possible injury, explosion or death, practice safe handling of refrigerants.

 **WARNING**
Refrigerants are heavier than air. They can "push out" the oxygen in your lungs or in any enclosed space. To avoid possible difficulty in breathing or death:

- **Never purge refrigerant into an enclosed room or space. By law, all refrigerants must be reclaimed.**
- **If an indoor leak is suspected, thoroughly ventilate the area before beginning work.**
- **Liquid refrigerant can be very cold. To avoid possible frostbite or blindness, avoid contact and wear gloves and goggles. If liquid refrigerant does contact your skin or eyes, seek medical help immediately.**
- **Always follow EPA regulations. Never burn refrigerant, as poisonous gas will be produced.**

 **WARNING**

To avoid possible explosion:

- **Never apply flame or steam to a refrigerant cylinder. If you must heat a cylinder for faster charging, partially immerse it in warm water.**
- **Never fill a cylinder more than 80% full of liquid refrigerant.**
- **Never add anything other than R-22 to an R-22 cylinder or R-410A to an R-410A cylinder. The service equipment used must be listed or certified for the type of refrigerant used.**
- **Store cylinders in a cool, dry place. Never use a cylinder as a platform or a roller.**

 **WARNING**

To avoid possible explosion, use only returnable (not disposable) service cylinders when removing refrigerant from a system.

- **Ensure the cylinder is free of damage which could lead to a leak or explosion.**
- **Ensure the hydrostatic test date does not exceed 5 years.**
- **Ensure the pressure rating meets or exceeds 400 lbs.**

When in doubt, do not use cylinder.

Refrigerant Lines

 **CAUTION**

The compressor POE oil for R-410A units is extremely susceptible to moisture absorption and could cause compressor failure. Do not leave system open to atmosphere any longer than necessary for installation.

Use only refrigerant grade (dehydrated and sealed) copper tubing to connect the condensing unit with the indoor evaporator. After cutting the tubing, install plugs to keep refrigerant tubing clean and dry prior to and during installation. Tubing should always be cut square keeping ends round and free from burrs. Clean the tubing to prevent contamination.

Do NOT let refrigerant lines come in direct contact with plumbing, ductwork, floor joists, wall studs, floors, and walls. When running refrigerant lines through a foundation or wall, openings should allow for sound and vibration absorbing material to be placed or installed between tubing and foundation. Any gap between foundation or wall and refrigerant lines should be filled with a pliable silicon-based caulk, RTV or a vibration damping material. Avoid suspending refrigerant tubing from joists and studs with rigid wire or straps that would come in contact with the tubing. Use an insulated or suspension type hanger. Keep both lines separate and always insulate the suction line.

These sizes are suitable for line lengths of 74 feet or less. If a run of more than fifty feet is required, refer to Remote Cooling Service Manual, or TP-106 Long Line Set Application R-22, or TP-107 Long Line Set Application R-410A or contact your distributor for assistance.

RECOMMENDED INTERCONNECTING TUBING (Ft)						
Cond Unit Tons	0-24		25-49		50-74*	
	Line Diameter (In. OD)					
	Suct	Liq	Suct	Liq	Suct	Liq
1 1/2	5/8	1/4	3/4	3/8	3/4	3/8
2	5/8	1/4	3/4	3/8	3/4	3/8
2 1/2	3/4	3/8	3/4	3/8	7/8	3/8
3	3/4	3/8	7/8	3/8	1 1/8	3/8
3 1/2	3/4	3/8	1 1/8	3/8	1 1/8	3/8
4	7/8	3/8	1 1/8	3/8	1 1/8	3/8
5	7/8	3/8	1 1/8	3/8	1 1/8	3/8

* Lines greater than 74 feet in length or vertical elevation changes more than 50 feet refer to the **Remote Cooling Service Manual** or contact your distributor for assistance.

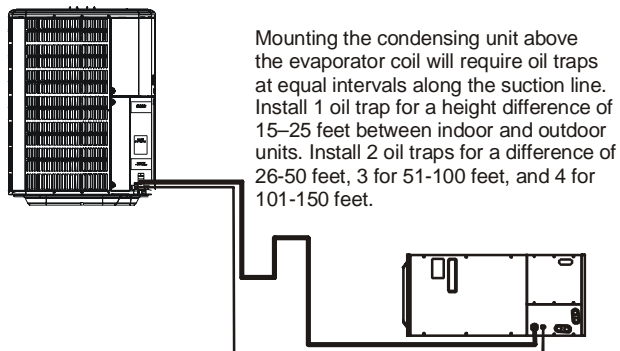
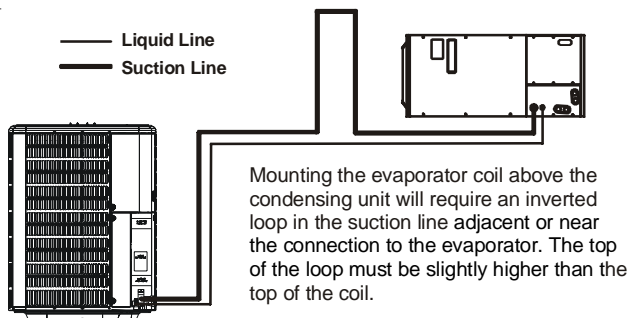

Insulation is necessary to prevent condensation from forming and dropping from the suction line. Armflex (or satisfactory equivalent) with 3/8" min. wall thickness is recommended. In severe conditions (hot, high humidity areas) 1/2" insulation may be required. Insulation must be installed in a manner which protects tubing from damage and contamination.

Where possible, drain as much residual compressor oil from existing systems, lines, and traps; pay close attention to low areas where oil may collect. **NOTE:** If changing refrigerant types, ensure the indoor coil and metering device is compatible with the type of refrigerant being used; otherwise, the indoor coil must be replaced.

Burying Refrigerant Lines

If burying refrigerant lines can not be avoided, use the following checklist.

1. Insulate liquid and suction lines separately.
2. Enclose all underground portions of the refrigerant lines in waterproof material (conduit or pipe) sealing the ends

where tubing enters/exits the enclosure.

3. If the lines must pass under or through a concrete slab, ensure lines are adequately protected and sealed.

Refrigerant Line Connections

IMPORTANT: To avoid overheating the service valve, TXV valve, or filter drier while brazing, wrap the component with a wet rag, or use a thermal heat trap compound as recommended by the compound manufacturer. Use a brazing alloy of 2% minimum silver content. Do not use flux.

1. The ends of the refrigerant lines must be cut square, deburred, cleaned, and be round and free from nicks or dents. Any other condition increases the chance of a refrigerant leak.
2. "Sweep" the refrigerant line with nitrogen or inert gas during brazing to prevent the formation of copper-oxide inside the refrigerant lines. The POE oils used in R-410A applications will clean any copper-oxide present from the inside of the refrigerant lines and spread it throughout the system. This may cause a blockage or failure of the metering device.
3. After brazing, quench the joints with water or a wet cloth to prevent overheating of the service valve.
4. Ensure the filter drier paint finish is intact after brazing. If the paint of the steel filter drier has been burned or chipped, repaint or treat with a rust preventative. This is especially important on suction line filter driers which are continually wet when the unit is operating.

NOTE: Be careful not to kink or dent refrigerant lines. Kinked or dented lines will cause poor performance or compressor damage.

Do NOT make final refrigerant line connection until plugs are removed from refrigerant tubing.

NOTE: Before brazing, verify indoor piston size by checking the piston kit chart packaged with indoor unit.

Leak Testing (Nitrogen or Nitrogen-Traced)

WARNING
To avoid the risk of fire or explosion, never use oxygen, high pressure air or flammable gases for leak testing of a refrigeration system.

WARNING
To avoid possible explosion, the line from the nitrogen cylinder must include a pressure regulator and a pressure relief valve. The pressure relief valve must be set to open at no more than 150 psig.

Pressure test the system using dry nitrogen and soapy water to locate leaks. If you wish to use a leak detector, charge the system to 10 psi using the appropriate refrigerant then use nitrogen to finish charging the system to working pressure then apply the detector to suspect areas. If leaks are found, repair

them. After repair, repeat the pressure test. If no leaks exist, proceed to system evacuation.

System Evacuation

Condensing unit liquid and suction valves are closed to contain the charge within the unit. The unit is shipped with the valve stems closed and caps installed. **Do not open valves until the system is evacuated.**

WARNING

REFRIGERANT UNDER PRESSURE!
Failure to follow proper procedures may cause property damage, personal injury or death.

1. Connect the vacuum pump with 250 micron capability to the service valves.
2. Evacuate the system to 250 microns or less using suction **and** liquid service valves. Using both valves is necessary as some compressors create a mechanical seal separating the sides of the system.
3. Close pump valve and hold vacuum for 10 minutes. Typically pressure will rise during this period.

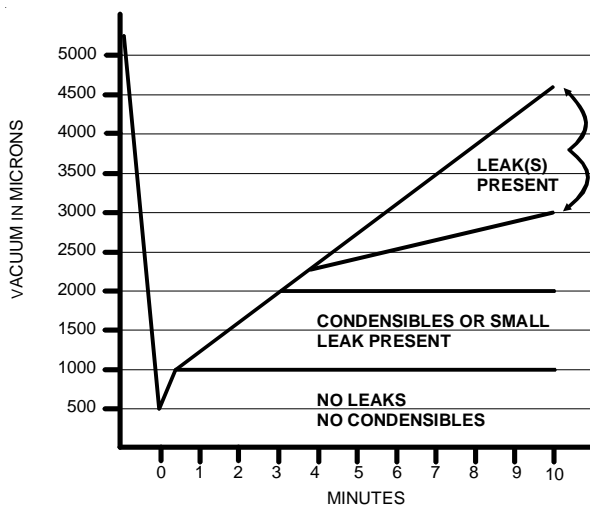

- If the pressure rises to 1000 microns or less and remains steady the system is considered leak-free; proceed to startup.
- If pressure rises above 1000 microns but holds steady below 2000 microns, moisture and/or noncondensibles may be present or the system may have a small leak. Return to step 2: If the same result is encountered check for leaks as previously indicated and repair as necessary then repeat evacuation.
- If pressure rises above 2000 microns, a leak is present.

Check for leaks as previously indicated and repair as necessary then repeat evacuation.

Electrical Connections

WARNING

HIGH VOLTAGE!

Disconnect ALL power before servicing. Multiple power sources may be present. Failure to do so may cause property damage, personal injury or death due to electric shock. Wiring must conform with NEC or CEC and all local codes. Undersized wires could cause poor equipment performance, equipment damage or fire.



WARNING

To avoid the risk of fire or equipment damage, use copper conductors.

NOTICE

Units with reciprocating compressors and non-bleed TXV's require a Hard Start Kit.

The condensing unit rating plate lists pertinent electrical data necessary for proper electrical service and overcurrent protection. Wires should be sized to limit voltage drop to 2% (max.) from the main breaker or fuse panel to the condensing unit. Consult the NEC, CEC, and all local codes to determine the correct wire gauge and length.

Local codes often require a disconnect switch located near the unit; do not install the switch on the unit. Refer to the installation instructions supplied with the indoor furnace/air handler for specific wiring connections and indoor unit configuration. Likewise, consult the instructions packaged with the thermostat for mounting and location information.

Overcurrent Protection

The following overcurrent protection devices are approved for use.

- Time delay fuses
- HACR type circuit breakers

These devices have sufficient time delay to permit the motor-compressor to start and accelerate its load.

Three Phase Compressor Rotation

CAUTION

Use care when handling scroll compressors. Dome temperatures could be hot.

Three phase compressors are power phase dependent and can rotate in either direction.

Verify proper rotation for three phase compressors by ensuring the suction pressure drops and discharge pressure rises when the compressor is energized. **NOTE:** When operated in reverse, a three phase scroll compressors is noisier and its current draw substantially reduced compared to marked values.

To correct, disconnect power and switch any two leads at the unit contactor and re-observe.

High Voltage Connections

Route power supply and ground wires through the high voltage port and terminate in accordance with the wiring diagram provided inside the control panel cover.

Low Voltage Connections

Condensing unit control wiring requires 24 Volt minimum, 25VA service from the indoor transformer. Low voltage wiring for two-stage units depends on the thermostat used and the number of control wires between the indoor unit and the condensing unit. Route control wires through the low voltage port and terminate in accordance with the wiring diagram provided inside the control panel cover.

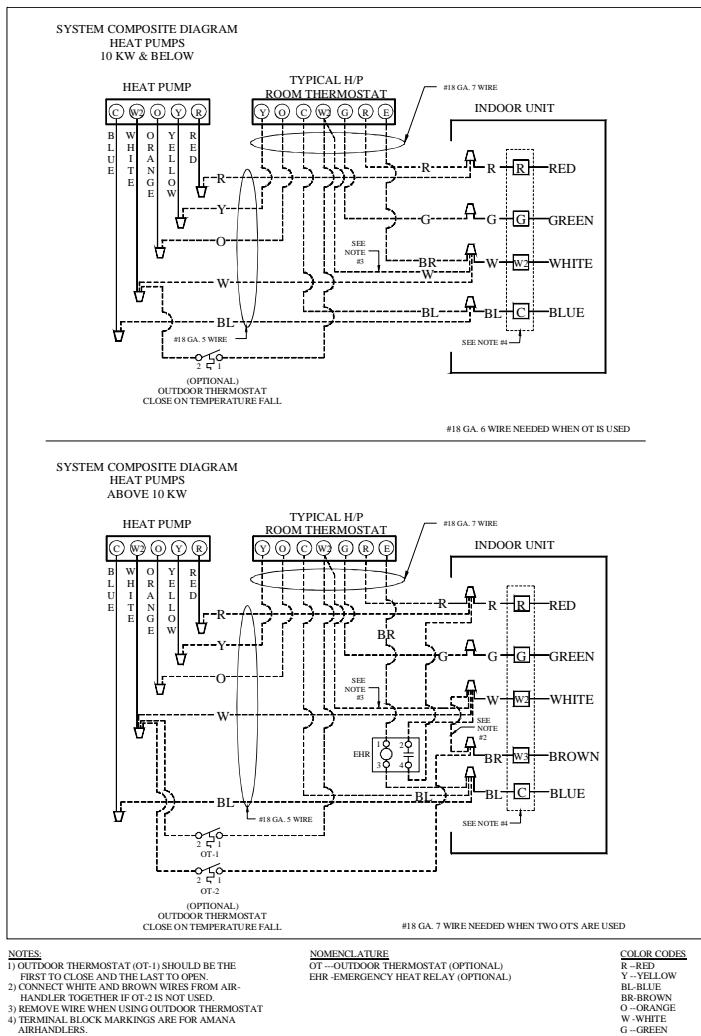

Thermostat

with Low Voltage Wires to Heat Pump Unit

NOTE: For two-stage units, refer to the Installation Instructions supplied with the variable speed indoor units for field wiring connections.

System Start Up

Adequate refrigerant charge for a matching evaporator and 15 feet lineset is supplied with the condensing unit. **NOTE:** If lineset exceeds 15 feet in length, refrigerant should be added at .6 ounces per foot of liquid line.

Open each valve only until the top of the stem is 1/8" from the retainer. To avoid loss of refrigerant, do not apply pressure to the retainer.

1. Break vacuum by fully opening liquid and suction base valves.
2. Set thermostat to call for cooling. Check indoor and outdoor fan operation and allow system to stabilize for 10 minutes for fixed orifices and 20 minutes for expansion valves.

Charge Verification

! WARNING

REFRIGERANT UNDER PRESSURE!

- Do not overcharge system with refrigerant.
- Do not operate unit in a vacuum or at negative pressure.

Failure to follow proper procedures may cause property damage, personal injury or death.

! CAUTION

Use refrigerant certified to ARI standards. Used refrigerant may cause compressor damage, and will void the warranty. Most portable machines cannot clean used refrigerant to meet ARI standards.

NOTICE

Violation of EPA regulations may result in fines or other penalties.

! CAUTION

Operating the compressor with the suction valve closed will void the warranty and cause serious compressor damage.

Final Charge Adjustment

The outdoor temperature must be 60°F or higher. Set the room thermostat to COOL, fan switch to AUTO, and set the temperature control well below room temperature.

After system has stabilized per startup instructions, check subcooling and superheat as detailed in the following section.

Fixed Orifice

! CAUTION

To prevent personal injury, carefully connect and disconnect manifold gauge hoses. Escaping liquid refrigerant can cause burns. Do not vent refrigerant into the atmosphere. Recover all refrigerant during system repair and before final unit disposal.

1. Purge gauge lines. Connect service gauge manifold to base-valve service ports. Run system at least 10 minutes to allow pressure to stabilize.
2. For best results, temporarily install a thermometer on the suction line near the compressor. The thermometer should be located within 4" to 6" of the compressor. Ensure the thermometer makes adequate contact and is insulated.

NOTE: An optional, less accurate, method is to locate the thermometer at the suction line service valve. Ensure the thermometer makes adequate contact and is insulated.

- Refer to the superheat table provided for proper system superheat. Add charge to lower superheat or recover charge to raise superheat.

SYSTEM SUPERHEAT					
Ambient Condenser Inlet Temp. (°F Drybulb)	Return Air Temperature (°F Drybulb)				
	65	70	75	80	85
115					3
100				5	5
95			5	5	5
90			7	12	18
85		5	10	17	20
80		5	12	21	26
75	5	10	17	25	29
70	5	14	20	28	32
65	13	19	26	32	35
60	17	25	30	33	37

- Disconnect manifold set, installation is complete.

Superheat Formula = Suct. Line Temp. - Sat. Suct. Temp.

SATURATED SUCTION PRESSURE TEMPERATURE CHART		
SUCTION PRESSURE	SATURATED SUCTION TEMPERATURE °F	
	PSIG	R-22
50	26	1
52	28	3
54	29	4
56	31	6
58	32	7
60	34	8
62	35	10
64	37	11
66	38	13
68	40	14
70	41	15
72	42	16
74	44	17
76	45	19
78	46	20
80	48	21

Expansion Valve System

Single Speed Application

- Purge gauge lines. Connect service gauge manifold to base-valve service ports. Run system at least 10 minutes to allow pressure to stabilize.
- Temporarily install thermometer on liquid (small) line near liquid line service valve with adequate contact and insulated for best possible reading.

late for best possible reading.

- Check subcooling and superheat. Systems with TXV application should have a subcooling of 7 ± 2 °F and superheat of 7 to 9 °F.

- If subcooling and superheat are low, **adjust** TXV to 7 to 9 °F superheat, then check subcooling.

NOTE: To adjust superheat, turn the valve stem clockwise to increase and counter clockwise to decrease.

- If subcooling is low and superheat is high, **add** charge to raise subcooling to 7 ± 2 °F then check superheat.
- If subcooling and superheat are high, **adjust** TXV valve to 7 to 9 °F superheat, then check subcooling.
- If subcooling is high and superheat is low, **adjust** TXV valve to 7 to 9 °F superheat and **remove** charge to lower the subcooling to 7 ± 2 °F.

NOTE: Do **NOT** adjust the charge based on suction pressure unless there is a gross undercharge.

- Disconnect manifold set, installation is complete.

Subcooling Formula = Sat. Liquid Temp. - Liquid Line Temp.

SATURATED LIQUID PRESSURE TEMPERATURE CHART		
LIQUID PRESSURE	SATURATED LIQUID TEMPERATURE °F	
	PSIG	R-22
200	101	70
210	105	73
220	108	76
225	110	78
235	113	80
245	116	83
255	119	85
265	121	88
275	124	90
285	127	92
295	130	95
305	133	97
325	137	101
355	144	108
375	148	112
405	155	118

Two Speed Application

Run the remote on low stage cooling for 10 minutes until refrigerant pressures stabilize. Follow the guidelines and methods below to check unit operation and ensure that the refrigerant charge is within limits. Charge the unit on low stage.

- Purge gauge lines. Connect service gauge manifold to base-valve service ports. Run system at least 10 minutes to allow pressure to stabilize.
- Temporarily install thermometer on liquid (small) line near

liquid line service valve with adequate contact and insulate for best possible reading.

3. Check subcooling and superheat. Systems with TXV application should have a subcooling of 5 to 7 °F and superheat of 7 to 9 °F.

a. If subcooling and superheat are low, **adjust** TXV to 7 to 9 °F superheat, then check subcooling.

NOTE: To adjust superheat, turn the valve stem clockwise to increase and counter clockwise to decrease.

b. If subcooling is low and superheat is high, **add** charge to raise subcooling to 5 to 7 °F then check superheat.

c. If subcooling and superheat are high, **adjust** TXV valve to 7 to 9 °F superheat, then check subcooling.

d. If subcooling is high and superheat is low, **adjust** TXV valve to 7 to 9 °F superheat and **remove** charge to lower the subcooling to 5 to 7 °F.

NOTE: Do **NOT** adjust the charge based on suction pressure unless there is a gross undercharge.

4. Disconnect manifold set, installation is complete.

Subcooling Formula = Sat. Liquid Temp. - Liquid Line Temp.

Heat Pump - Heating Cycle

The proper method of charging a heat pump in the heat mode is by weight with the additional charge adjustments for line size, line length, and other system components.

NOTICE

Units with reciprocating compressors and non-bleed TXV's require a Hard Start Kit.

Troubleshooting Information

Complaint	No Cooling						Unsatisfactory Cooling/Heating						System Operating Pressures				Test Method Remedy			
	SYMPTOM	System will not start	Compressor will not start - fan runs	Comp. and Cond. Fan will not start	Evaporator fan will not start	Condenser fan will not start	Compressor runs - goes off on overload	Compressor cycles on overload	System runs continuously - little cooling/hgt	Too cool and then too warm	Not cool enough on warm days	Certain areas too cool, others too warm	Compressor is noisy	System runs - blows cold air in heating	Unit will not terminate defrost	Unit will not defrost		Low suction pressure	Low head pressure	High suction pressure
Power Failure	●																			Test Voltage
Blown Fuse	●		●	●																Inspect Fuse Size & Type
Unbalanced Power, 3PH		●					●													Test Voltage
Loose Connection	●			●			●													Inspect Connection - Tighten
Shorted or Broken Wires	●	●	●	●	●	●														Test Circuits With Ohmmeter
Open Fan Overload				●	●															Test Continuity of Overload
Faulty Thermostat	●		●	●				●												Test Continuity of Thermostat & Wiring
Faulty Transformer	●		●																	Check Control Circuit with Voltmeter
Shorted or Open Capacitor		●		●	●	●	●													Test Capacitor
Internal Compressor Overload Open		●											◆							Test Continuity of Overload
Shorted or Grounded Compressor		●																		Test Motor Windings
Compressor Stuck		●					●						◆							Use Test Cord
Faulty Compressor Contactor			●		●	●														Test Continuity of Coil & Contacts
Faulty Fan Relay				●																Test Continuity of Coil And Contacts
Open Control Circuit				●																Test Control Circuit with Voltmeter
Low Voltage		●				●	●													Test Voltage
Faulty Evap. Fan Motor				●												●		◆		Repair or Replace
Shorted or Grounded Fan Motor					●													●		Test Motor Windings
Improper Cooling Anticipator							●													Check Resistance of Anticipator
Shortage of Refrigerant							●	●					◆			●	●			Test For Leaks, Add Refrigerant
Restricted Liquid Line							●	●								●	●			Remove Restriction, Replace Restricted Part
Open Element or Limit on Elec. Heater								◆					◆							Test Heater Element and Controls
Dirty Air Filter								●	●	●									◆	Inspect Filter-Clean or Replace
Dirty Indoor Coil								●	●	●									◆	Inspect Coil - Clean
Not enough air across Indoor Coil								●	●	●						●			◆	Check Blower Speed, Duct Static Press, Filter
Too much air across Indoor Coil									●	●							◆	●		Reduce Blower Speed
Overcharge of Refrigerant						●	●					●	◆					●	●	Recover Part of Charge
Dirty Outdoor Coil						●	●			●							◆			Inspect Coil - Clean
Noncondensibles							●		●				◆						●	Recover Charge, Evacuate, Recharge
Recirculation of Condensing Air							●		●										●	Remove Obstruction to Air Flow
Infiltration of Outdoor Air							●	●	●	●										Check Windows, Doors, Vent Fans, Etc.
Improperly Located Thermostat						●			●											Relocate Thermostat
Air Flow Unbalanced								●	●											Readjust Air Volume Dampers
System Undersized								●	●											Refigure Cooling Load
Broken Internal Parts												●	◆							Replace Compressor
Broken Valves								●				●					●	●		Test Compressor Efficiency
Inefficient Compressor								●					◆				●	●		Test Compressor Efficiency
Wrong Type Expansion Valve						●	●	●	●							●	●	◆		Replace Valve
Expansion Device Restricted						●	●	●	●							●	●			Remove Restriction or Replace Expansion Device
Oversized Expansion Valve							●												●	Replace Valve
Undersized Expansion Valve						●	●	●	●							●				Replace Valve
Expansion Valve Bulb Loose												●							●	Tighten Bulb Bracket
Inoperative Expansion Valve						●		●								●				Check Valve Operation
Loose Hold-down Bolts												●								Tighten Bolts
Faulty Reversing Valve						●							◆	◆	◆		◆	◆	◆	Replace Valve or Solenoid
Faulty Defrost Control					●								◆	◆	◆	◆	◆	◆	◆	Test Control
Faulty Defrost Thermostat													◆	◆	◆	◆	◆	◆	◆	Test Defrost Thermostat
Flowrator Not Seating Properly								●									●	●		Check Flowrator & Seat or Replace Flowrator

● Cooling or Heating Cycle (Heat Pump)

◆ Heating Cycle Only (Heat Pump)

For detailed service information refer to the Remote Condensing Unit Service manual.